

**FLYING on FOILS, but most importantly PILOTING, that is the QUESTION.****The discovery of flight on foils**

This technique has remained confidential for a very long time because it was the prerogative of a few informed amateurs.

The flight of the MOTH showed us that it was impressive, and apparently easy except for the agility of the pilot (helmsman?).



Everything seems simple, no additional energy, just wind and sea, a very simple (but intelligent) servo system associated with the dexterity of a funambulist pilot.

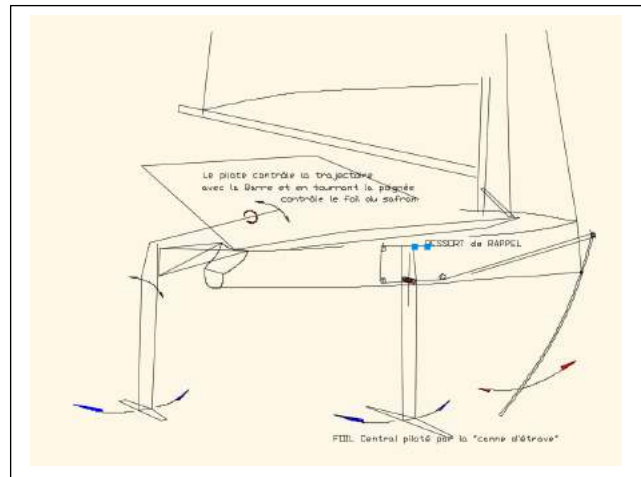

However, experience shows that the reality of pilotage appears much more complex when the boat (Foiler) weighs 7 tons (IMOCA) or 15 tons (ULTIMATE Trimaran). It seems that the moving masses of these foilers exceed the pilots' reactions.

**In the beginning was...**

The idea of leaving the Archimedean mode, where the boat traces its path in the ocean and evolves supported by lifting plans (wings), does not date back to today.

But the initiators of this method quickly understood that it was necessary to take off first before finding a more or less stable flight regime based on water.

We notice that all this appeared in the 1890s / 1910s, at the same time as the first aircraft, the internal combustion engines becoming more powerful and lighter.

I would even say that a foiler behaves like a seaplane.

Before you can fly with your wings or foils on, you have to leave the "Archimedean" mode and for that you need power, a lot of power.

The analogy with the plane continues. The first flights were flea jumps: we took off and flew a certain distance at an uncertain altitude and landed as best we could.

At the very beginning of the 20th century, the first controlled motorized flights took place, this meant that the pilot take off from point A, made a more or less long flight controlling his route and altitude and returned to land at point A.

In fact, the rudder (which had already existed for several centuries on ships) had been invented and the incidence of the wing could be varied in order to fly, take off and land, but also to keep the altitude as constant as possible.

Today all this seems obvious, but it was much less so when aerodynamics was in its early stages. The most funny thing is that all the engineers who are passionate about planes, but also the "wonderful flying fools on their funny machines" throw themselves on the hydrodynamic work that Osborne REYNOLDS (English engineer 1842 -1912) had done in 1883 for ships. These works were immortalized under the name of the Reynolds Number.

This Reynolds Number is a dimensionless number, it corresponds to the ratio between the inertial forces of the molecules of a fluid and the viscosity forces of the same fluid. It depends on the body profile, travel speed and fluid viscosity.

The most surprising thing is that Reynolds will carry out all its studies for ships and particularly propellers and therefore for water as a fluid. All this work will be transposed onto aircraft wings and fuselages, both in subsonic and supersonic mode, 70 years later.

### But back to the foils.

The aerodynamic part of the foils was quickly resolved. Naturally there have been changes in the choice of profiles, but engineers now have a very complete literature (NACA, GOE, SOKOLOV, EPLLER profiles etc.).

A foil is a wing and its lift obviously depends on its shape (symmetrical, thick, curved etc.) but this lift is closely related to the angle of incidence, i.e. the angle between the direction of the fluid and the wing profile rope.

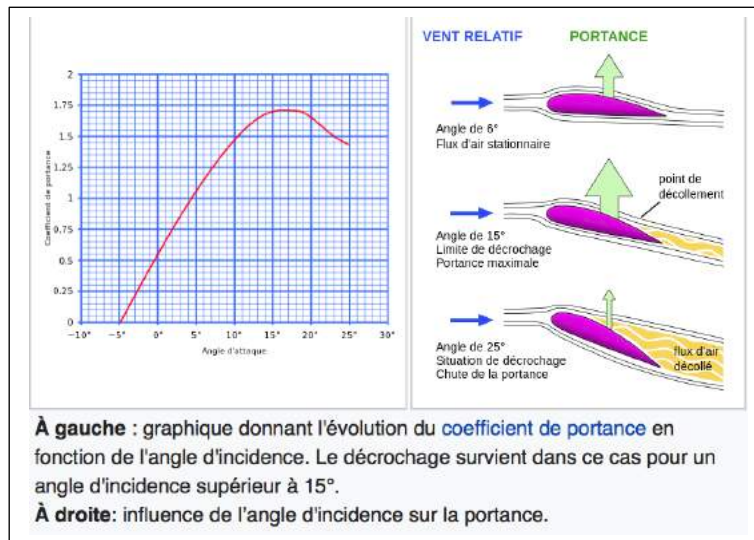

For each profile, the maximum bearing capacity area corresponds to a very precise angle of incidence. The lift is relatively proportional to the angle of incidence up to a maximum value. But a few degrees more and it is the almost immediate stall, i. e. a zero lift.

It can be seen that the almost linear progression phase of the lift is accompanied by the increase in drag ("negative" element)

The adjustment range to obtain the maximum lift is very narrow. Some profiles are more tolerant than others, but this is a compromise, which results in lower performance.

In summary, the objective is:

To choose a profile that produces lift, let us not forget that it is lift that extracts the boat from the Archimedean regime and makes it "fly" against its foils, the fluid being water.

To control the angle of incidence so as not to stall and see the lift drop, which will result in a brutal transition from the foiler regime to the Archimedean regime. The speed can then drop from 60% to 70%. This hydrodynamic change can result in capsizing.

It is also possible that as a result of a pitching effect, the boat may end up with a negative pitch trim, i.e., it suddenly starts to dive down.

Then the direction of the fluid attacking the foil's lower back changes sides and attacks the upper back. This immediately reverses the direction of lift, and the foil drop (it then acts like the dive bars of a submarine), which is not very pleasant, nor the desired effect.

**When the control of a foiler becomes very complex.**

On an Archimedean sailboat, the helmsman manages the trajectory (rudder) and regulates the power of the Mainsail. Its crew member (for example on a dinghy) regulates the jib power and ensures the transverse and longitudinal trim of the boat.

But the boat remains permanently in the Archimedean domain, it nevertheless takes some liberties, when it hovers, but still the hull must be suitable.

Reactions can then become more sneaky.

On a foiler, it is also necessary to control the Foil.

Several possibilities will be explored with varying degrees of success.

In "OPEN" races (1980s), the foils were installed with a fixed incidence in relation to the geometry of the multihull (see "PAUL RICARD" for example)

We quickly realized that this was not really the solution.

The Hydroptère has improved this system by adding an adjustable horizontal wing on the central rudder, but there have been many setbacks. In fact, flight stability was too dependent on piloting.



Based on these experiences, engineers turned to "self-regulated" foils, then quickly to controlled regulation foils.

Self-regulation involves a more or less immersed V-shaped foil form between the Archimedean mode and the foiler mode.

With a V-shaped foil (or several), the effect of the lift when lifting the boat will cause the partial lifting of the foil, this will result in a decrease in the active surface, therefore a decrease in the lift, therefore a "lowering" effect of the boat... which increases the active surface, therefore the lift... We thus create an almost automatic regulation of the flight altitude.

It is this "elevator" effect that is supposed to generate a more or less constant flight height by modulating the active surface.

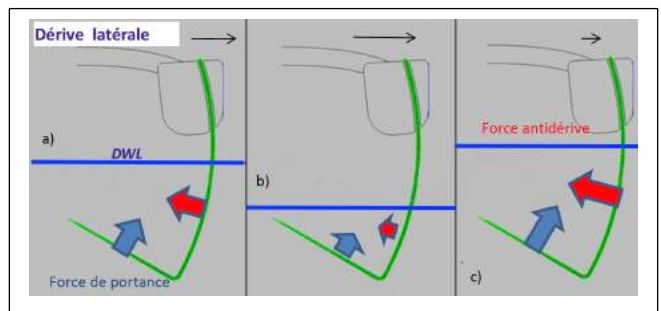

When the foil incidence is fixed, the crew uses the boat's longitudinal trim (TRIM) to fine-tune it. But as soon as the boat is big, this solution is no longer usable.

Speed being a component of the "lift" effect, it necessarily intervenes, which means that the incidence must be modified to fly at a constant altitude.

We see that self-regulation is not the quintessence for ensuring a stable flight.

The size, the weight of the self-regulated foils and the forces involved require very robust internal structures.



Finally, the "V" Foils allow a relatively low flight altitude (because of the "V"), which increases the risk of loading and braking stress during self-regulation.

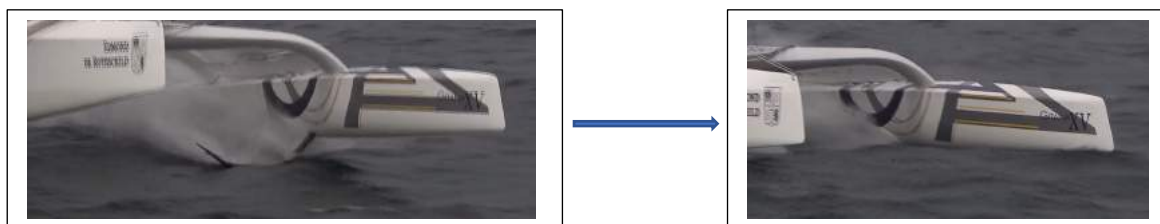

IMOCAs use "V" foils a lot.

Whether they are named "DALI" or otherwise, the shape of these foils depends closely on the IMOCA Class rule.



« *V pur* »



« *V évasé + dérive verticale* »



« *V + DSS<sup>1</sup> + dérive verticale* »

The IMOCA Class Rules limit the number of appendages and the number of degrees of freedom of each appendage.

Number of appendages: maximum 5, i.e. 2 foils (or centerboard), 2 rudders, 1 fin keel.

Degrees of freedom:

- For Foils / centerboard: 2, a translation from top to bottom and vice versa and a rotation from front to back and vice versa, limited to 5°.
- For the fin keel: a rotation with the axis in the plane of symmetry
- For rudders: a rotation that control the boat (helmsman) (a rotation for lifting the rudder is allowed if it does not contribute to improving the performance of the rudder)

It is therefore forbidden to add a horizontal wing on the rudders, which is a serious handicap.

<sup>1</sup> « DSS » = names a straight foil or a substantially horizontal curve (like an aircraft wing)

These constraints lead architects to compete for ideas to find the Foil of the "5-legged sheep" type, i.e. at the same time:

- Self-regulating foil ("V") to limit the use of incidence control and to cushion the effects of trim changes (nose-up, nose-down, heel-down, heel-up) and drift.
- Horizontal Foil (DSS) because it is the shape that generates the most lift.
- Small vertical winglet implanted under the bottom of the "V" or under the "DSS".
- Anti-vortex winglet.

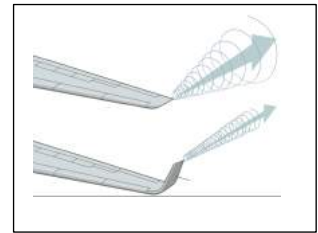

Winglet (anti vortex)

These specifications are very complex.

Effect on navigation: an IMOCA is raised on its leeward foil and its canting keel, which, due to its inclined axis, provides a little lift despite its symmetrical profile and on the aft side of the surface of its hull.



### The boat's seat on the water in Foiler mode.

Regardless of the type of boat, the important point is the seating surface on the water in foiler mode. Indeed, each supporting wing can be assimilated to contact with water as a single point.

For a solid to be automatically stable, only 3 support points are required.

The farmers quickly discovered that to make a stool for milking cows, 3 feet was enough to have good stability when sitting down.

For a foiler, the rule is the same (!).



The advantage of the multihull is in its natural design, which generates a triangle with a large rear base (distance between the rudders).

For a Monohull, it is more complicated because of its width and its ratio Width / Length.

If it is equipped with 2 rudders, the configuration:

A wing on each rudder + a wing on the leeward foil (and the canting keel) is possible for boats with a BMAX / LH ratio of about 0.45.

The Mini SEAIR 747 which is 6.5 X 3.0 is an example (see below left).



If it is equipped with a single rudder, the configuration becomes:

Two wings very far apart and far forward + one horizontal wing on the rudder (see above right).

But there are always exceptions to a rule, see the MOTH.

LOA 3.55m, Sailing: 8m<sup>2</sup>, Rigged weight: 35kg,

Sailing displacement 115 kg with an 80 kg helmsman

- Main symmetrical T-wing main support plane in the center.

- Symmetrical T-wing secondary on the rudder.

**For balance... a funambulist skipper.**

It works very well, but it cannot be transposed.

Well, almost...



***Controlled flight altitude regulation becomes essential as soon as horizontal wings are used. The Foiler then flies like a plane.***

Example of a central "L" wing (foil) on a multihull.

This means that there must be one or more control systems that allow the balance of the Foiler to be adjusted when it is in flight.

The hull evolves relatively near the surface of the water.

The Trim (pitch) depends on controlling the foilers longitudinal balance. This is called "centering" on an aircraft, i.e. the movement of the foiler around its center of gravity according to the incidence of its rear wing.

Changing the incidence on the center foils affects the lift value, but in no way controls the flight path.



### Longitudinal equilibrium conditions

The point of balance is the boat's Centre of Gravity. The Foiler rotates permanently around this point.

There are three couples:

The torque created by the propulsive force of the sails. It's a couple to be pricked around the CG.

The torque created by the LIFT (lift) of the Foils (opposite direction to the previous one). It is a torque to be reared around the CG.

The torque generated by the wing of the horizontal foil that equips the rudder is either a torque to be raised or a torque to be tilt.

**The control of this torque (wing of the rudder) allows to balance the sum of the torques generated by the sail force and the foils force.**

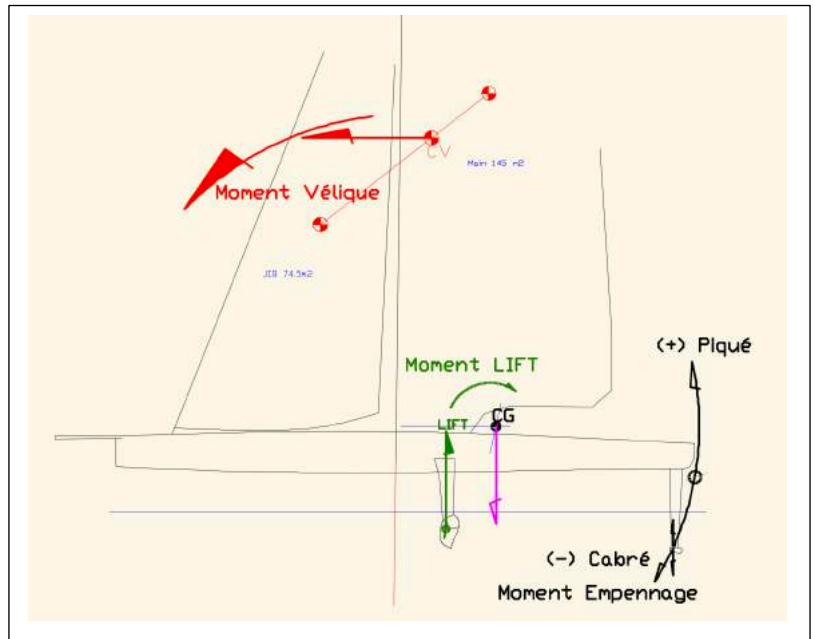

**This corresponds to controlled regulation.**

Opposite and above: wing retractable vertically on a rudder and fletner controlling the rotation of the rudder.



But this balance is possible only if the boat's Centering is a "Rear Centering," i. e. its center of gravity when sailing is located behind the center of lift of the forward foils.

This corresponds to the balance:

$$\text{Torque Sail} = \text{Torque Lift} + \text{Torque Empennage AR.}$$

### Transversal equilibrium conditions

The longitudinal equilibrium conditions are identical to those of an aircraft (with the exception of the height of the propelling force).

On a foiler, the transverse component of the propulsive force still exists (reminiscences of the Archimedean mode). This component will have to be taken into account if you do not want to capsize. This implies that the following three forces:

Weight of the boat

Vertical Lift produced by the foils

Force produced by the sails (its transverse component).

Must be concurrent.

This relationship is very complex to obtain at all times because one parameter is totally independent of the pilot: the real wind speed, which is one of the components of the apparent wind.

## Implementation to ensure flight conditions.

The number of appendices and their degrees of freedom, they depend essentially on the rules of the Classes.

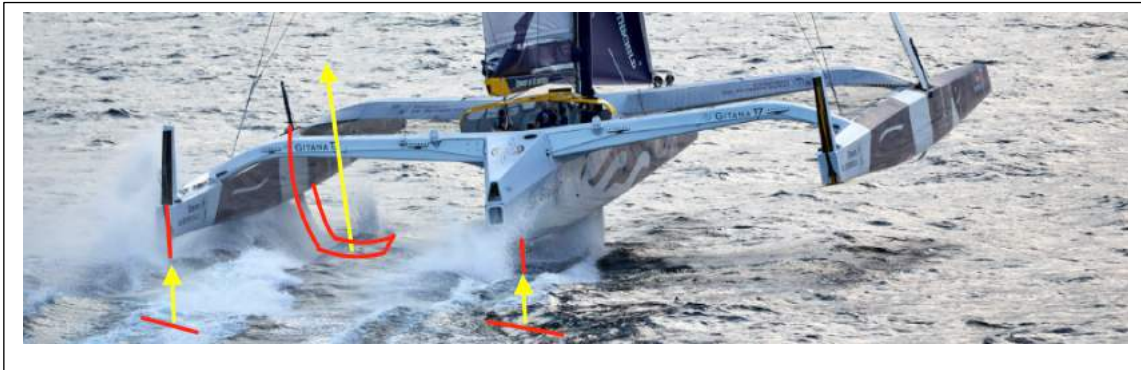

Some Classes, including the IMOCA Class, impose restrictive rules. In contrast, other Classes leave all freedom.

Let us return to the means to be implemented in order to ensure good flying conditions by taking the example of "ULTIMATE" trimarans:

### ➤ **Two horizontal wings at the rear attached to the rudders (central hull and leeward float).**

*The wing on the rudder from the hull to the wind is raised.*

*This horizontal wing will have a symmetrical profile because its lift will have to alternate, either upwards or downwards in order to generate the torque to be tilt or the torque to be reared from the platform.*

- Two methods are used either:
  - The rudder has only the conventional rotational movement (vertical axis). The wing is equipped with a flap that can be adjusted from  $-20^\circ$  to  $+20^\circ$ , for example, thus reversing the direction of lift. This is effective because the large adjustment angle of the flap allows a high sensitivity of the lift capacity. However, it is more complex in terms of engineering.
- The wing, which is also symmetrical, is fixed on the rudder. The lift reversal is achieved by rotating the rudder about an axis perpendicular to the plane of symmetry of the float or central hull (this system works a bit like the TRIM of an outboard motor). The mechanical system appears to be less flexible to manage than the trailing edge flap technique.

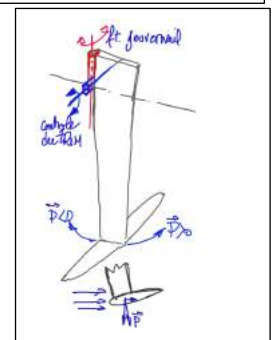
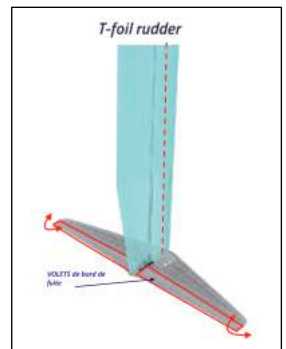

### ➤ **A main support on the leeward hull (L-foil).** *The "power" of the Lift is in this foil. It will therefore be animated by the maximum number of possible controls.*

- An adjustment of the transverse angle from the inside to the outside and vice versa (called "Cant")
- An adjustment of the angulation from front to back and vice versa to modify the angle of incidence (called "Rake").
- An adjustment of the orientation (vertical axis) (named "Yaw")

These controls are used to modulate the "power" of the lift and indirectly to reduce the drag.

In the end, each foil has 4 degrees of freedom (3 rotations  $O_x$ ,  $O_y$ ,  $O_z$  and a  $T_y$  translation)

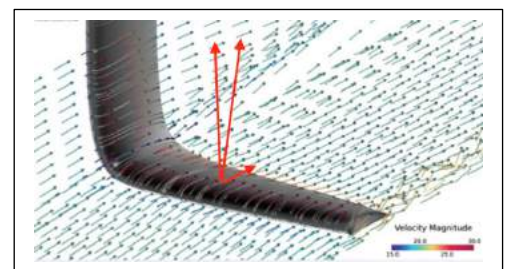

Each movement (excluding translation) will be obtained by an electric or hydraulic actuator because the forces involved are high and the lever arms for applying them are short.



### The technological means to obtain these movements.

Rule 52 "MANUAL ENERGY" of the RCV (World Sailing) specifies that "*sails, movable hull appendages shall be adjusted and maneuvered only by the force provided by the crew*".

The Class Rules necessarily amend this rule.

On a 30-metre Foiler, the moving masses and speed of movement generate very high forces and require reaction times that exceed the crew's capabilities.

The industry produces actuators (a combination of a hydraulic cylinder and its control system). Some also have their own integrated energy source.

These equipment are numerous, particularly in the aeronautical field.

On Foilers, the required cylinder strokes are relatively small at 100 to 350 mm.

At the speed at which the boat flies, over the water, control of the foil and aft wing is essential. This control must be reactive, accurate and reliable.

What has just been stated already poses a problem because if mechanically this technology is known and universally used, its installation on a boat will require Class managers to reflect and write very precisely Rule 52 (above).



### The concept of "open loop" or "closed loop"..

These are the basic concepts for any mechanical action whatsoever.

The "**Open Loop**" (OL) is the most basic solution: It is a regulation without any control or feedback between the input (what we want to obtain) and the output of the system (what is actually achieved).

*Example:* A mobile has a speed of 1m/s.

The instruction to be carried out is a displacement of 100m.

In open loop, you operate the motor for 100s.

Normally at the end of these 100s, the mobile has arrived at its destination, unless there is a headwind.

In "open loop", you assume that everything went well, which is not the case in this example.

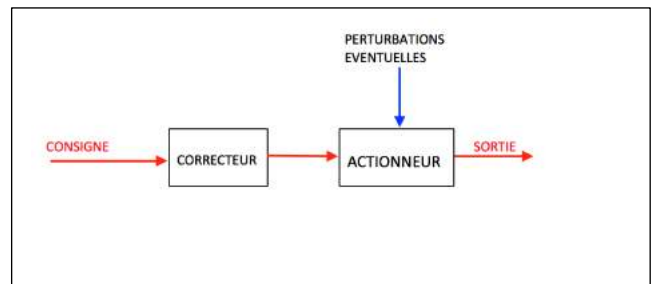

The "**Closed Loop**" (CL) is more sophisticated.

The principle is as follows:

The desired setpoint, here 100m, is constantly compared to the actual value at time t.

A comparator has been added that continuously calculates the difference between the objective to be achieved and the actual distance travelled.

It is only when this difference is zero that the system is stopped.

The "Closed loop" corresponds to the human being.

We move, among other actions, permanently in a "closed loop".

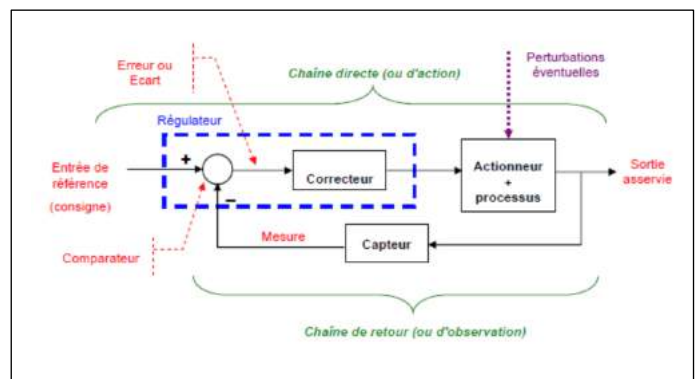

### Is the "Closed Loop" the only key to a stable flight for a foiler?

It quickly appears that it is not by installing closed loops on all actuators (control cylinders) that flight stabilization problems will be solved. This is simply because the number of settings is too large for the pilot to be able to control them consistently and adequately.

An actuator (e. g. a hydraulic or electric tiller cylinder) can operate in an open loop (OL), it is then considered that it carries out what is imposed on it, without result control, or it can operate in a closed loop (CL), the movement information is sent to it until the desired set point is reached.

The automatic pilots of our CL boats are preferable to those of OL, although the latter give satisfaction. But we are in Archimedean mode where the speeds are low and the influence of the environment more stable.

On a foiler, it is not necessary to reason by controlling each actuator, but by controlling groups of actuators (Subsystems).

Subsystems must be managed, for example for the FOIL which has 3 degrees of freedom (3 rotations possible) in addition to its vertical translation, this FOIL will be equipped with 3 hydraulic actuators.

It is not enough for each actuator to fulfill the instructions imposed on it, they must necessarily correspond consistently to what is expected of FOIL at this moment.

In fact, the problem is reversed.

When faced with a situation, the pilot decides on an **immediate reaction**.

This reaction assumes that different instructions are immediately sent to each of the actuators until the end of the **pilot's request (his reaction) is validated**.

It is on this **request** that the "closed loop" is transferred.

The CLs of each actuator are obviously necessary, but the key is in controlling the pilot's demand. As long as the instructions related to this demand are not met, the various actuators must be independently supplied with information (the impact of one flap is increased, that of another flap is less so, etc.).

Finally, between the pilot who activates the joystick to trigger his reaction and the actuators of the subsystem, there will necessarily be an algorithm that will calculate, transmit and control the execution of the action.

All in Closed Loop.

This principle is applied on cars with ESP and ABS. Faced with an unexpected and unpredictable event, the driver reacts by acting on the steering wheel. Receiving this information, the two algorithms of the ESP and ABS, act by independently braking the wheels to correct the car's trajectory.

Everything is done without the pilot's intervention, other than his perception of the trajectory he transmits through the rotation of the steering wheel and the pressure on the brake pedal and/or the accelerator.

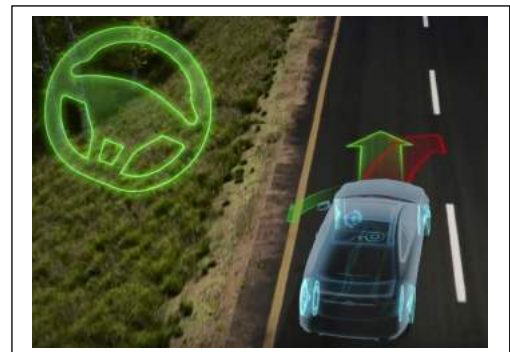

On a Foiler, it is even more complex, because the pilot's request will not concern the Foil alone (and its actuators), but the movement of the platform as a whole, i.e. its flight in 3D whereas for a car we evolve in 2D.

Consequently, the algorithm will manage all the actuators taking into account the pilot's wishes but also external parameters (wind, wind angle, sea conditions, speed, heel, Trim, etc.). The algorithm becomes the DIRECTOR of FLIGHT.

### **Pilot Perception and Reaction versus Algorithm Reaction.**

Confronted with an event, an incident, a modification during the flight, the pilot's perception, analysis and response time is much longer than that of the sensors and analyses of the ad-hoc algorithm.

We can add that it is not so obvious that the answer (his reaction) of the pilot is the most appropriate to tackle this event and this even if it seems rational at a glance.

*Example:* Example: Adjusting the mainsail in the event of a wind gust seems to be the logical reaction of the crew, but very often this is not enough a serious problem.

The algorithm, through the information transmitted by the sensors (boat heel and trim, wind acceleration, rudder angle, etc.) will react instantly to the event and control the actuators dedicated to piloting.

However, it is possible to control without the use of algorithms. The proof is provided by the pilots of acrobatic aircraft (see Red Bull Air race) where all the maneuvers they initiate are exclusively manual, without any control or decision-making aid.

Pilots only benefit from visual information (dashboard displays, trajectory visualization) and their body's perception of aircraft movements.

Only one limit is imposed on them, it is the driving time, therefore the concentration.

On a Foiler, the navigation and "flight" time is very long (especially singlehanded race). It should be added that, unlike acrobatic flights, the fluid in which the Foiler operates is much less homogeneous than that surrounding the aircraft and the regularity of the available power.

The level of technicality of a Foiler modifies the navigation and mainly its control, the rules of the Archimedean domain are no longer applicable to the Foiler mode.

### **Which level of aid authorized within the meaning of Rule 52 "MANUAL ENERGY" of the RRS.**

There are four levels of authorization.

**Level 0:** All actuators operate in an "open loop" (OL).

This is the case for sailboats in general.

When a crew member operates the actuator, it is an "open loop", in the sense that it is the crew member's perception that advises him to stop operating the hydraulic pump or hoist. When he reads the anemometer, he interprets the reading.

The only intervention of an algorithm appears in a navigation and routing software, which uses immediate data (anemometer, speed, wind angle, weather file, etc.) to provide route predictions at 12, 24, 36 hours.

**Level 1:** The actuators operate independently in a "closed loop".

The AC75s (catamarans or Foilers to come) operated on this principle.

The navigator and helmsman have a number of pre-established navigation schemes, each corresponding to actuator presets.

The navigator and helmsman choose the most appropriate diagram for the navigation segment to be carried out. They only have the possibility to adjust certain settings within very limited ranges in order to refine the flight parameters.

But everything depends on the configuration of the navigation schemes identified in advance and on the crew members.

The sail adjustments are manual (OL), with winches or even actuators.

**Level 2:** This is how the MOTH flight works.

On a MOTH, there is a central main foil and a rear wing (symmetrical profile) at the end of the rudder (which acts as a rear empennage of an aircraft).

The lift providing the flight is fully provided by the main wing (end centerboard). This function is fully controlled by using an articulated "detection rod" located on the bow. This sensor drags in the water and provides information on flight height and speed.

This information is transmitted by sets of connecting rods and a simple mechanical system to orient the main foil (lift).

On some MOTH models, the pilot has an additional power control of the lift by pre-orienting the rake of this foil.

But this regulation is fully automatic.

The rudder body is articulated, in addition to the vertical axis, around a transverse axis, which has the effect of allowing the rear wing to generate a downward lift or an upward lift.

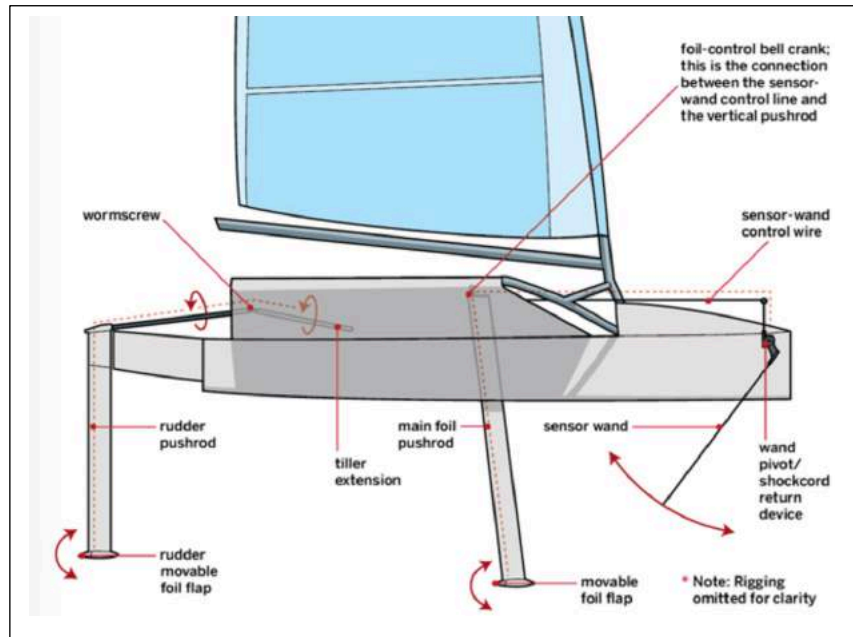

Depending on the direction of this lift, the MOTH will pitch up or nose-down. As a result, it maintains an almost permanent horizontal pitch.

But it is the pilot who ensures the manual control of the rear wing and refines the flight conditions (heel, gust wind etc.)

The MOTH is a bad example of a monohull on a foil, because lateral balance only exists because the helmsman is a **tightrope walker**.

This configuration is impossible to imagine on a monohull that would like to fly in an identical configuration completely above the water.

The classification in **Level 2** is justified by the fact that there is a whole part of the flight management that is fully automated. The front sensor and its transmission components represent a kind of autonomous mechanical algorithm.

**Level 3:** All actuators operate independently in a (CL) "closed loop" BUT these actuators are grouped into subsystems (e. g. all those dedicated to a foil, all those dedicated to the rudder, etc). Each actuator belonging to an entity receives continuous position information.

These instructions are continuously managed by a closed loop servo system so that the entity can fulfil its mission.

All these entities are managed by a **general algorithm** that contains **the basic flight equations**.

This general algorithm integrates the external parameters (real wind, apparent wind, heading, speed, etc.) as well as the platform attitude, sail settings.

This general algorithm provides each entity with an objective, and each entity is responsible for using its own algorithm to provide the necessary instructions to its component actuators and for continuously reporting to it on the progress of the instruction.

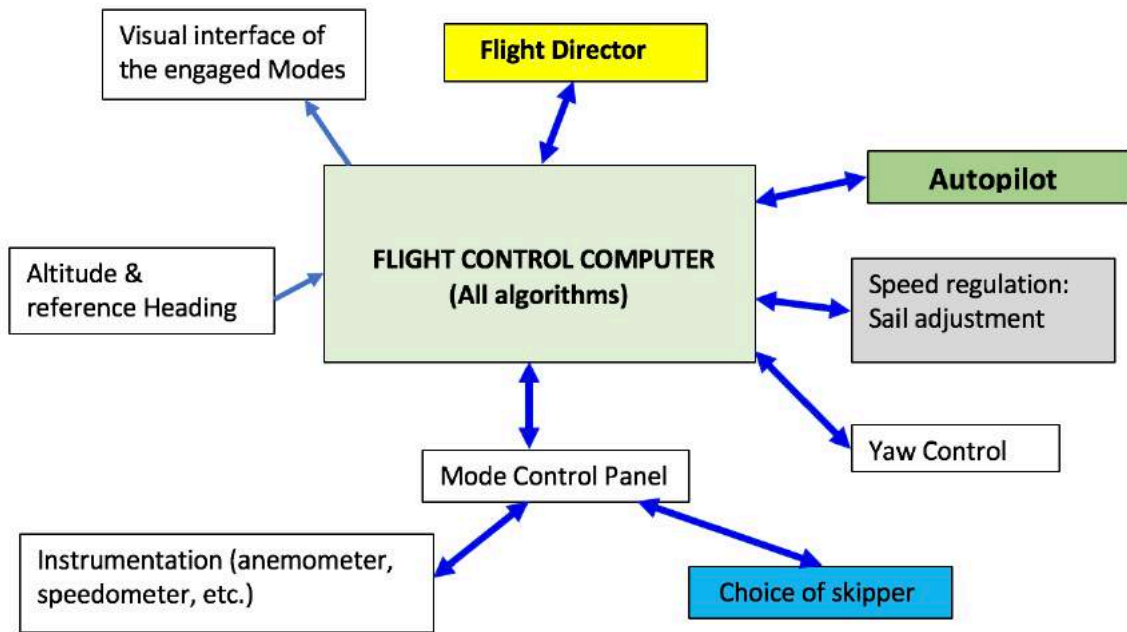

The answer to the question **What level of aid allowed under Rule 52** depends on the regulations issued by the Classes or Organizers.

This could be summarized as an alternative:

### To race with or without "Artificial Intelligence"?

In other words, if we limit ourselves to Levels 1 and 2, we must admit, and this is all the more true in singlehanded race:

- ✓ That the pilot will voluntarily limit the optimal use of his boat. We are talking about 50 to 60% for a ULTIMATE singlehanded race.
- ✓ That in some cases, even in manual piloting, the pilot will be "overtaken" by the power of the machine and that he will suffer it without being able to regain control of it.
- ✓ That, even in a deliberately "degraded" regime, the risk of loss of control of the boat and a possible crash remains high.
- ✓ That the myth of easy navigation in good weather no longer exists because of the apparent wind generated by foil sailing (recently a foil kite sailed at 24 knots in a real 6 knot wind).

But if **Level 3** is the rule, then it is **the sport mode that is degraded** because it is the performance of algorithms and servo systems that become preponderant.

### Cruel dilemma?

#### Finally, what about energy?

Except the MOTH, all the other Foilers are very voracious in electric energy and therefore for the transoceanic Foilers in fossil energy.

This is a significant deviation from the concept of clean sport, which often wishes to be attached to offshore racing.

Jean SANS (30 October 2018)